

14.5 Triangle Congruence Review Activity

1.

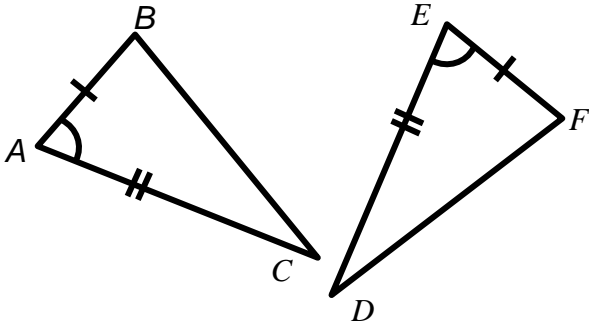

2.

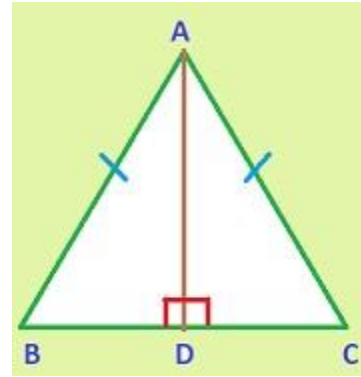

3.

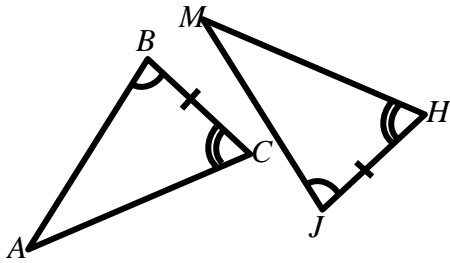

4.

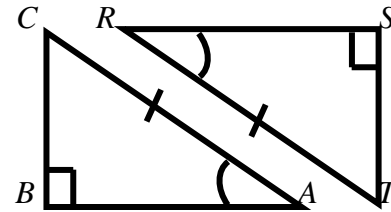

5.

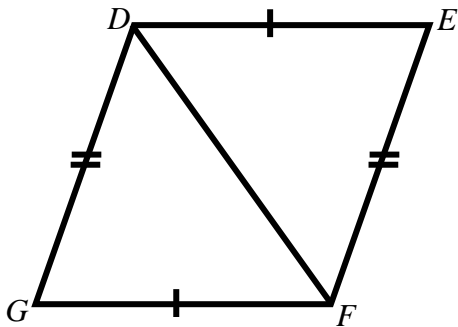

6.

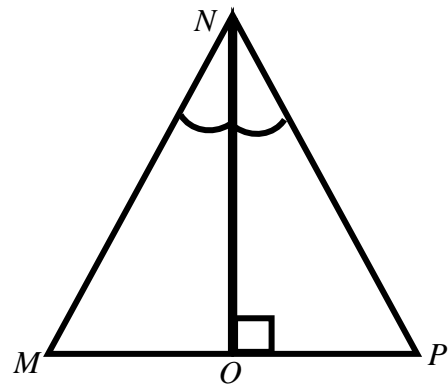

7.

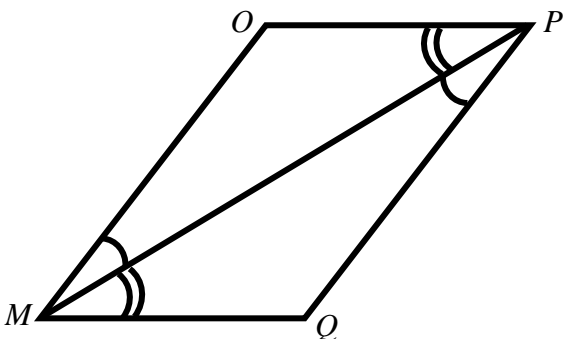

8.

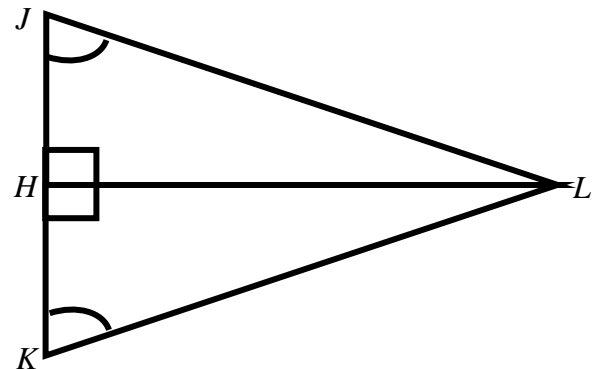

9.

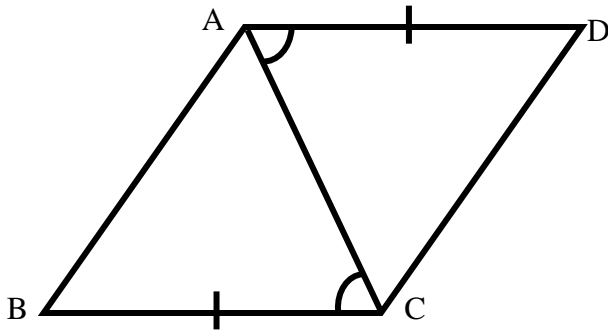

10.

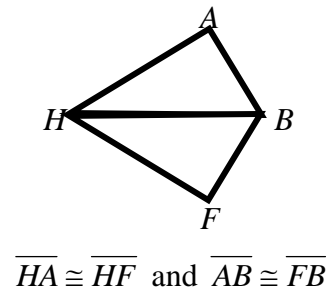

11.

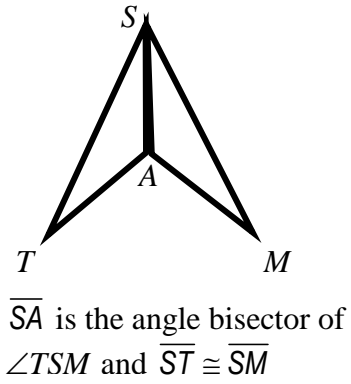

12.

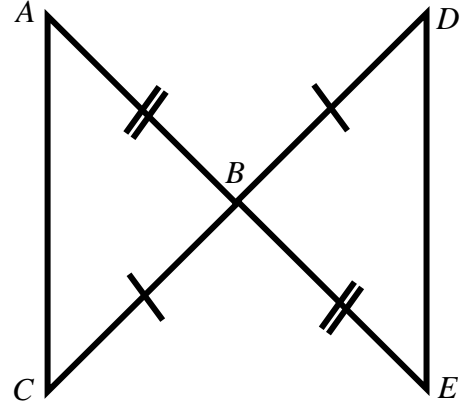

13.

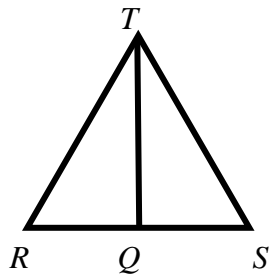

$\triangle RTS$ is isosceles with legs \overline{RT} and \overline{TS}
 Q is the midpoint of \overline{RS} .

14.

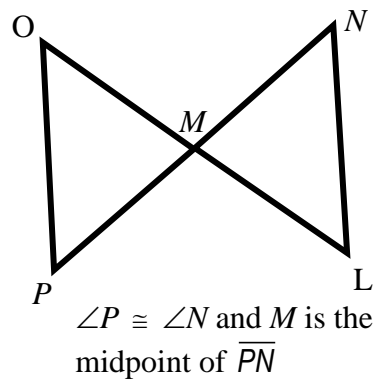

15.

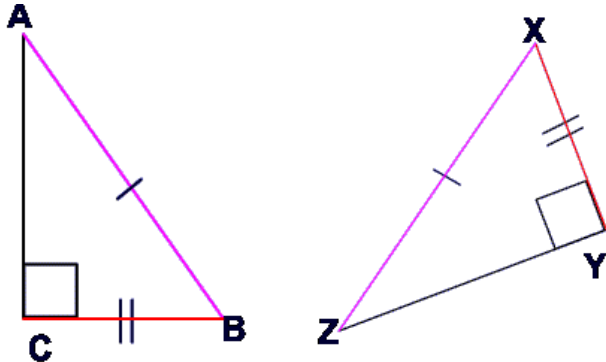

16.

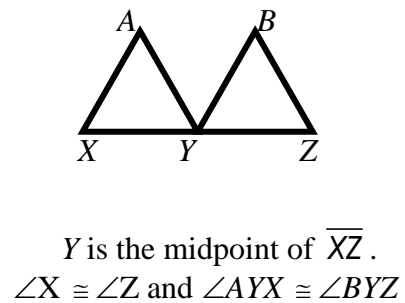

Name: _____ Period: _____ Date: _____

Triangle Congruence Review Recording Sheet

Problem	Congruent Angles & Sides	Triangle Congruence Statement	Reason
1.	$\overline{AB} \cong \overline{EF}$ S $\angle A \cong \angle E$ A $\overline{AC} \cong \overline{ED}$ S	$\triangle ABC \cong \triangle EFD$	SAS
2.			
3.			
4.			
5.			
6.			
7.			
8.			

9.			
10.			
11.			
12.			
13.			
14.			
15.			
16.			